

DrayTek

VigorLTE 200 Series

LTE Router



QUICK START GUIDE (RF MODEL)

V1.2

VigorLTE 200 Series LTE Router Quick Start Guide (For RF Model)

Version: 1.2

Firmware Version: V3.9.8.2

(For future update, please visit DrayTek web site)

Date: October 13, 2022

Intellectual Property Rights (IPR) Information

Copyrights

© All rights reserved. This publication contains information that is protected by copyright. No part may be reproduced, transmitted, transcribed, stored in a retrieval system, or translated into any language without written permission from the copyright holders.

Trademarks

The following trademarks are used in this document:

- Microsoft is a registered trademark of Microsoft Corp.
- Windows, 8, 10, 11 and Explorer are trademarks of Microsoft Corp.
- Apple and Mac OS are registered trademarks of Apple Inc.
- Other products may be trademarks or registered trademarks of their respective manufacturers.

Safety Instructions and Approval

Safety Instructions

- Read the installation guide thoroughly before you set up the router.
- The router is a complicated electronic unit that may be repaired only be authorized and qualified personnel. Do not try to open or repair the router yourself.
- Do not place the router in a damp or humid place, e.g. a bathroom.
- Do not stack the routers.
- The router should be used in a sheltered area, within a temperature range of +5 to +40 Celsius.
- Do not expose the router to direct sunlight or other heat sources. The housing and electronic components may be damaged by direct sunlight or heat sources.
- Do not deploy the cable for LAN connection outdoor to prevent electronic shock hazards.
- Keep the package out of reach of children.
- When you want to dispose of the router, please follow local regulations on conservation of the environment.

Warranty

We warrant to the original end user (purchaser) that the router will be free from any defects in workmanship or materials for a period of two (2) years from the date of purchase from the dealer. Please keep your purchase receipt in a safe place as it serves as proof of date of purchase. During the warranty period, and upon proof of purchase, should the product have indications of failure due to faulty workmanship and/or materials, we will, at our discretion, repair or replace the defective products or components, without charge for either parts or labor, to whatever extent we deem necessary to restore the product to proper operating condition. Any replacement will consist of a new or re-manufactured functionally equivalent product of equal value, and will be offered solely at our discretion. This warranty will not apply if the product is modified, misused, tampered with, damaged by an act of God, or subjected to abnormal working conditions. The warranty does not cover the bundled or licensed software of other vendors. Defects which do not significantly affect the usability of the product will not be covered by the warranty. We reserve the right to revise the manual and online documentation and to make changes from time to time in the contents hereof without obligation to notify any person of such revision or changes.



Declaration of Conformity

Hereby, DrayTek Corporation declares that the radio equipment type VigorLTE 200 is in compliance with Directive 2014/53/EU. The full text of the EU Declaration of Conformity is available at the following internet address:

https://fw.draytek.com.tw/VigorLTE_200/Document/CE

Manufacturer: DrayTek Corp.

Address: No.26, Fushing Rd., Hukou, Hsinchu Industrial Park, Hsinchu 303, Taiwan

Product: VigorLTE 200 Series

Frequency Information for Europe area:

2.4G WLAN	2412MHz - 2472 MHz, max. TX power: 19.98dBm *1
LTE	B1[1920-1980 MHz (TX); 2110-2170 MHz (RX)]; B3[1710-1785 MHz (TX); 1805-1880 MHz (RX)]; B7[2500-2570 MHz (TX); 2620-2690 MHz (RX)]; B8[880-915 MHz (TX); 925-960 MHz (RX)]; B20[832-862 MHz (TX); 791-821 MHz (RX)]; *2
3G	B1[1920-1980 MHz (TX); 2110-2170 MHz (RX)]; B8[880-915 MHz (TX); 925-960 MHz (RX)] *2

(*1: for 2.4G WLAN model; *2: for LTE model)

This product is designed for LTE and 2.4GHz WLAN network throughout the EC region.



Regulatory Information

Federal Communication Commission Interference Statement

This equipment has been tested and found to comply with the limits for a Class B digital device, pursuant to Part 15 of the FCC Rules. These limits are designed to provide reasonable protection against harmful interference in a residential installation. This equipment generates, uses and can radiate radio frequency energy and, if not installed and used in accordance with the instructions, may cause harmful interference to radio communications. However, there is no guarantee that interference will not occur in a particular installation. If this equipment does cause harmful interference to radio or television reception, which can be determined by turning the equipment off and on, the user is encouraged to try to correct the interference by one of the following measures:

- Reorient or relocate the receiving antenna.
- Increase the separation between the equipment and receiver.
- Connect the equipment into an outlet on a circuit different from that to which the receiver is connected.
- Consult the dealer or an experienced radio/TV technician for help.

This device complies with Part 15 of the FCC Rules. Operation is subject to the following two conditions:

- (1) This device may not cause harmful interference, and
- (2) This device may accept any interference received, including interference that may cause undesired operation.

RF Exposure Warning

This equipment must be installed and operated in accordance with provided instructions and the antenna(s) used for this transmitter must be installed to provide a separation distance of at least 20 cm from all persons and must not be co-located or operating in conjunction with any other antenna or transmitter. End-users and installers must be provided with antenna installation instructions and transmitter operating conditions for satisfying RF exposure compliance.

USA Local Representative	Company name	ABP International Inc.		
	Address	13988 Diplomat Drive Suite 180 Dallas TX 75234		
	ZIP Code	75234	E-mail	rmesser@abptech.com
	Contact Person	Mr. Robert Messer	Tel.	19728311600

Caution: Any changes or modifications not expressly approved by the party responsible for compliance could void the user's authority to operate the equipment.

The antenna/transmitter should be kept at least 20 cm away from human body.

External Power Supply ErP Information

	1	2	3	4	5	6	7	8	9
A Manufacturer	CWT	CWT	CWT	CWT	CWT	APD	APD	APD	APD
B Address	No. 222, Sec. 2, Nankan Rd., Lujhu Township, Taoyuan County 338, Taiwan	No. 222, Sec. 2, Nankan Rd., Lujhu Township, Taoyuan County 338, Taiwan	No. 222, Sec. 2, Nankan Rd., Lujhu Township, Taoyuan County 338, Taiwan	No. 222, Sec. 2, Nankan Rd., Lujhu Township, Taoyuan County 338, Taiwan	No. 222, Sec. 2, Nankan Rd., Lujhu Township, Taoyuan County 338, Taiwan	No. 5, Lane 83, Lung-Sou St., Taoyuan City 330, Taiwan	No. 5, Lane 83, Lung-Sou St., Taoyuan City 330, Taiwan	No. 5, Lane 83, Lung-Sou St., Taoyuan City 330, Taiwan	No. 5, Lane 83, Lung-Sou St., Taoyuan City 330, Taiwan
C Model identifier	2ABB012F UK 2ABB012F EU	2ABB018F UK 2ABB018F EU	2ABLO24F UK 2ABLO24F EU	2ABLO30F UK 2ABLO30F EU	2ABNO36F UK 2ABNO36F EU	WA-12M12FG WA-12M12FK	WB-18D12FG WB-18D12FK	WA-24Q12FG WA-24Q12FK	WA-36A12FG WA-36A12FK
D Input voltage	100-240V	100-240V	100-240V	100-240V	100-240V	100-240V	100-240V	100-240V	100-240V
E Input AC frequency	50/60Hz	50/60Hz	50/60Hz	50/60Hz	50/60Hz	50/60Hz	50/60Hz	50/60Hz	50/60Hz
Output voltage DC	12.0V	12.0V	12.0V	12.0V	12.0V	12.0V	12.0V	12.0V	12.0V
F Output current	1.0A	1.5A	2.0A	2.5A	3.0A	1.0A	1.5A	2.0A	3.0A
G Output power	12.0W	18.0W	24.0W	30.0W	36.0W	12.0W	18.0W	24.0W	36.0W
H Average active efficiency	84.9%	86.2%	87.6%	87.8%	89.8%	83.7%	85.4%	88.6%	88.2%
I Efficiency at low load 10%	73.6%	78.0%	81.3%	83.3%	83.7%	74.5%	80.5%	86.4%	85.4%
J No-load power consumption	0.07W	0.07W	0.07W	0.07W	0.07W	0.07W	0.10W	0.07W	0.10W

*The external power supply used for each product will be model dependent.

For more update, please visit www.draytek.com.



Table of Contents

1. Package Content	1
2. Panel Explanation.....	2
3. Hardware Installation	4
3.1 Network Connection	4
3.2 Wall-Mounted Installation	5
4. Software Configuration	6
4.1 Quick Start Wizard for Network Connection.....	6
5. Customer Service	10
Be a Registered Owner	10
Firmware & Tools Updates	10

1. Package Content

Take a look at the package content. If there is anything missed or damaged, please contact DrayTek or dealer immediately.



Vigor Router

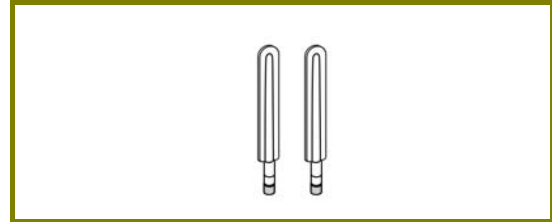

LTE Antenna

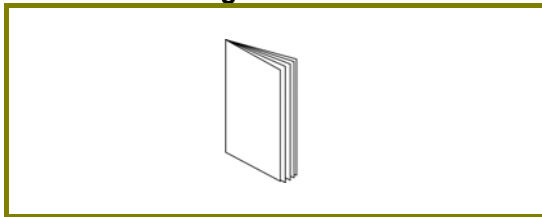

Quick Start Guide

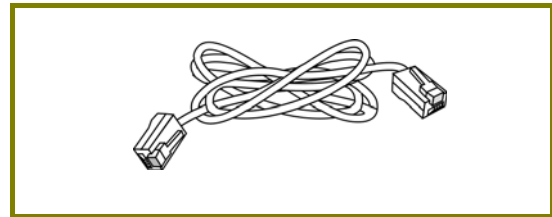

RJ-45 Cable (Ethernet)

The type of the power adapter depends on the country that the router will be installed.

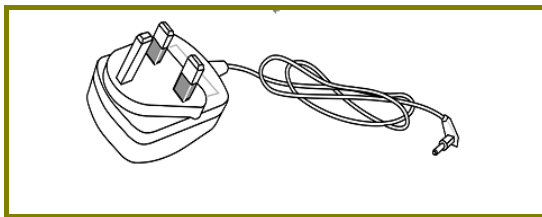

UK-type Power Adapter

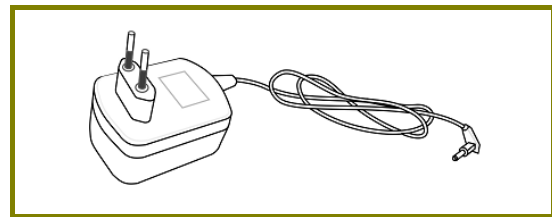

EU-type Power Adapter

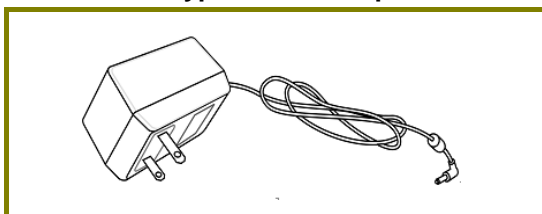

USA/Taiwan-type Power Adapter

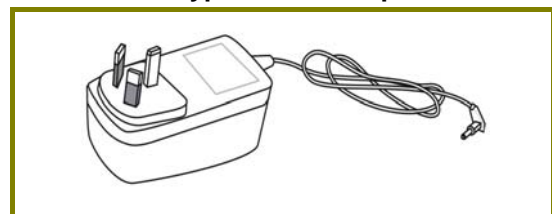

AU/NZ-type Power Adapter







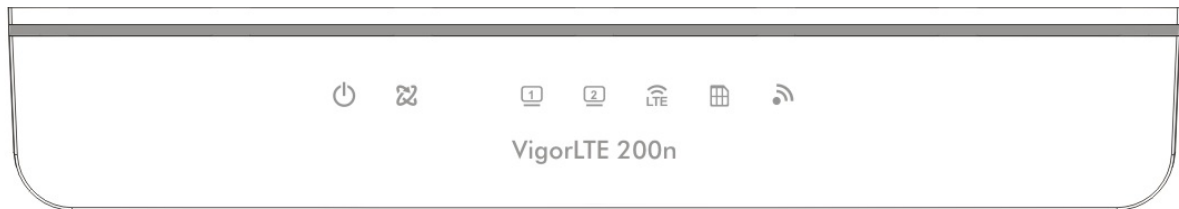
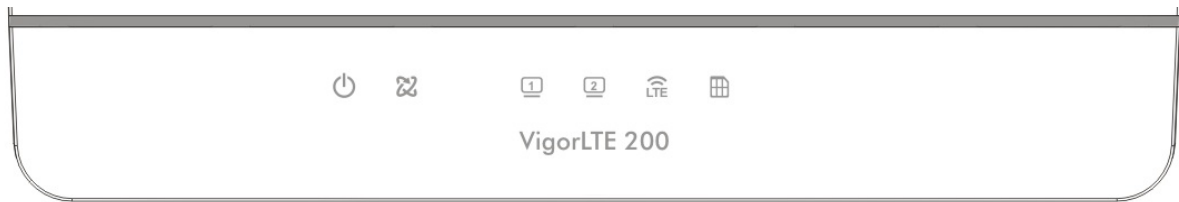

Note

Remove the protective film from the router before use to ensure ventilation.

2. Panel Explanation



LED	Status	Explanation
	Off	The router is powered off.
	Blinking	The router is powered on and running normally.
	On	The router is ready to access Internet.
	Off	The router is not ready to access Internet.
	Blinking	Slowly: The network connection is ready. Quickly: The network connection is establishing.
 	On	The LAN port is connected.
	Blinking	The data is transmitting through the LAN port.
	On	LTE device is connected and ready for use.
	Off	LTE device is not detected, or has serious problem (e.g., no SIM card, SIM pin error, SIM deactivated, and etc.).
	Blinking	Vigor device performs initial access procedure.
	On	SIM card is inserted into the slot and detected by Vigor device.
	Blinking	No SIM card in detected.
	On	Wireless function is enabled.
	Off	Wireless function is disabled.
	Blinking	The data is transmitting via wireless connection. Blinks with one second cycle for two minutes. The WPS function is active.

VigorLTE 200,

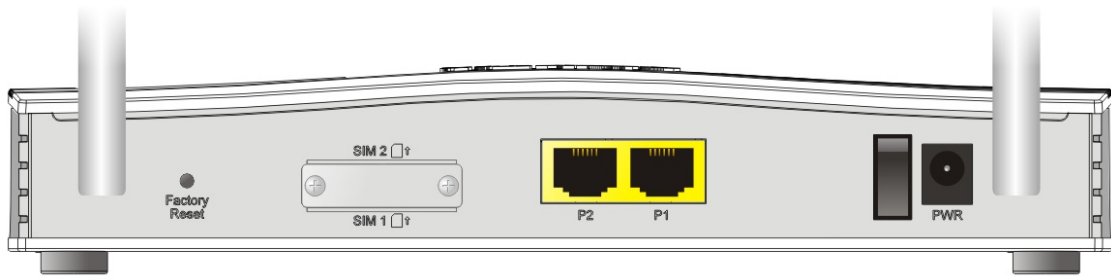

VigorLTE 200n,

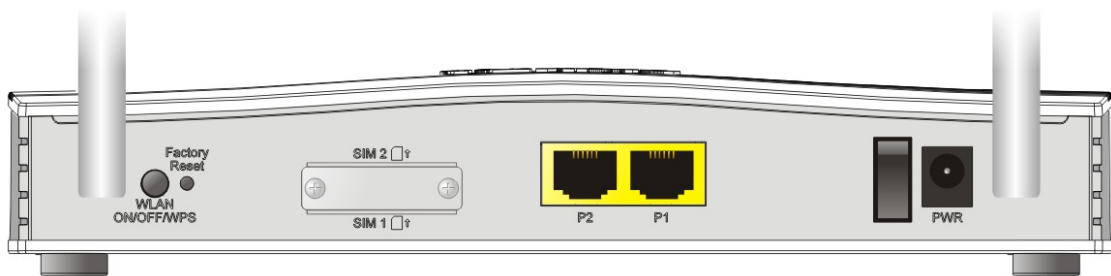

Interface	Description
Factory Reset	Restore the default settings. Usage: Turn on the router (ACT LED is blinking). Press the hole and keep for more than 5 seconds. When you see the ACT LED begins to blink rapidly than usual, release the button. Then the router will restart with the factory default configuration.
SIM2/SIM1	SIM card slot(s).
P2-P1	Connecters for local network devices.
ON/OFF	Power Switch.
PWR	Connector for a power adapter.

3. Hardware Installation

This section will guide you to install the router through hardware connection and configure the router's settings through web browser.

Before starting to configure the router, you have to connect your devices correctly.

3.1 Network Connection

1. Install the SIM card into the card slot. The back plate of the SIM card slot must be removed first and the direction of card notch must be on the left side.



After installing the SIM card, fasten the back plate again.

2. Connect to your computer with a RJ-45 cable.
3. Connect one end of the power cord to the power port of this device. Connect the other end to the wall outlet of electricity.
4. Power on the router.
5. Check the **power**, **LTE** and **LAN** LEDs to assure network connections.

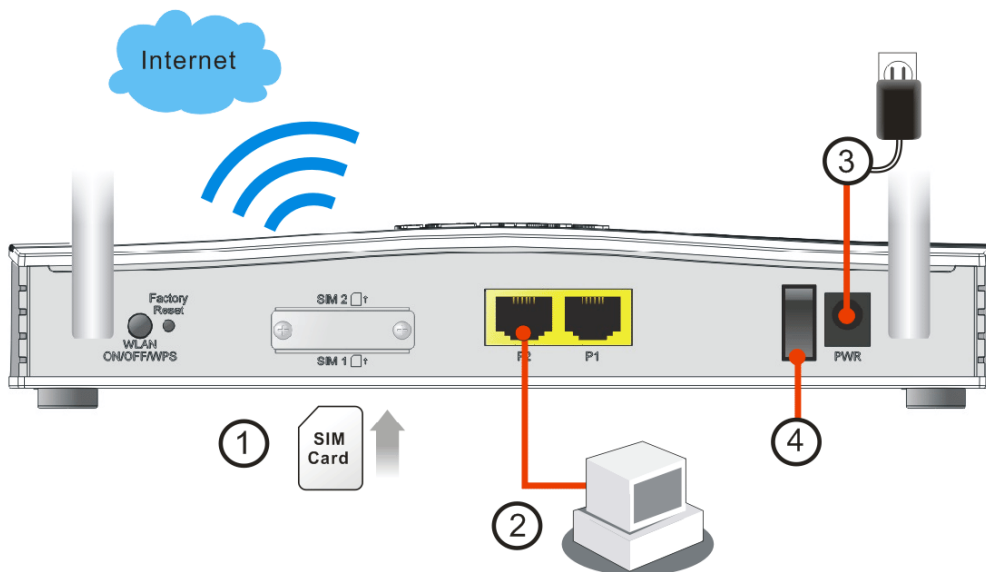

3.2 Wall-Mounted Installation

Vigor router has keyhole type mounting slots on the underside.

1. Drill two holes on the wall. The distance between the holes shall be 168mm.
2. Fit screws into the wall using the appropriate type of wall plug.

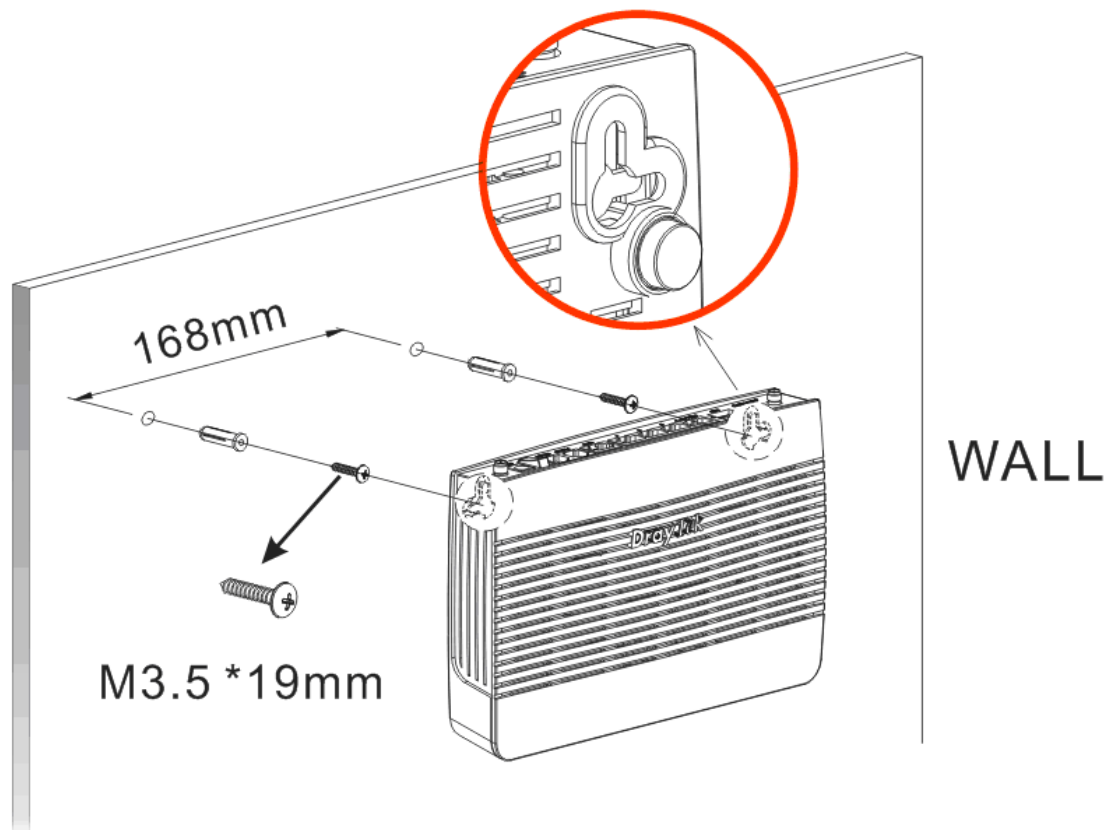

Note

The recommended drill diameter shall be 6.5mm (1/4").

3. When you finished about procedure, the router has been mounted on the wall firmly.

4. Software Configuration

To access Internet, please finish basic configuration after completing the hardware installation.

4.1 Quick Start Wizard for Network Connection

The **Quick Start Wizard** is designed for you to easily set up your router for Internet access. You can directly access the **Quick Start Wizard** via Web User Interface. Make sure your PC connects to the router correctly.



Note

You may either simply set up your computer to get IP dynamically from the router or set up the IP address of the computer to be the same subnet as the **default IP address of Vigor router 192.168.1.1**. For the detailed information, please refer to - Trouble Shooting of the user's guide.

Open a web browser on your PC and type **http://192.168.1.1**. A pop-up window will open to ask for username and password. Please type "admin/admin" as the Username/Password and click **Login**.

DrayTek **VigorLTE 200 Series**

Login

Username

Password

Login

Security Warning: You are logging in without encryption which is not recommended. To login securely [click here](#).

Copyright © 2000- 2018 DrayTek Corp. All Rights Reserved.



Note

If you fail to access to the web configuration, please go to "Trouble Shooting" on User's Guide for detecting and solving your problem.

Now, the Main Screen will pop up. Click **Wizards>>Quick Start Wizard**.

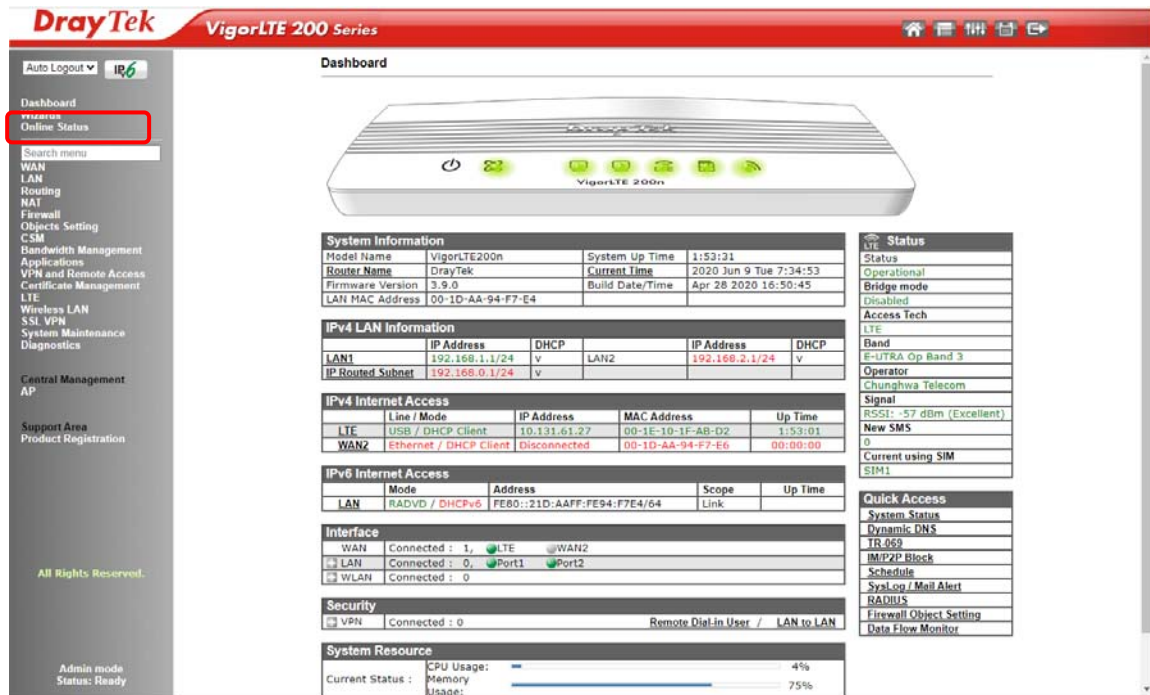

Note

The home page will change slightly in accordance with the router you have.

1. If your router can be under an environment with high speed NAT, the configuration provide here can help you to deploy and use the router quickly. The first screen of **Quick Start Wizard** is entering login password. After typing the password, please click **Next**.

Quick Start Wizard

Enter login password

Please enter an alpha-numeric string as your **Password**.

Old Password

New Password

Confirm Password

Hint: If you want to keep the password unchanged, leave the password blank and press "Next" button to skip this process.

< Back Next > Finish Cancel

2. On the next page, please select the WAN interface that you use. If DSL interface is used, please choose WAN1; if USB interface is used, please choose LTE. Then click Next for next step. WAN1 and LTE will bring up different configuration page. Here, we take LTE as an example.

Quick Start Wizard

WAN Interface

WAN Interface:	<input type="text" value="LTE"/>
Display Name:	<input type="text"/>
Physical Mode:	USB

3. Click Next to go to the following page.

Quick Start Wizard

Connect to Internet

LTE	
Internet Access :	<input type="text" value="3G/4G LTE Modem(DHCP mode)"/>
3G/4G LTE Modem(DHCP mode)	
SIM PIN code	<input type="text"/>
Network Mode	<input type="text" value="4G/3G"/> (Default:4G/3G)
APN Name	<input type="text"/>

4. Manually enter SIM PIN code and SPM Name provided by your ISP. Then click **Next** for viewing summary of such connection.

Quick Start Wizard

Please confirm your settings:

WAN Interface:	LTE
Physical Mode:	USB
Internet Access:	DHCP

Click **Back** to modify changes if necessary. Otherwise, click **Finish** to save the current settings and restart the Vigor router.

5. Click **Finish**. A page of **Quick Start Wizard Setup OK!!!** will appear. Then, the system status of this protocol will be shown.
6. Now, you can enjoy surfing on the Internet.

5. Customer Service

If the router cannot work correctly after trying many efforts, please contact your dealer for further help right away. For any questions, please feel free to send e-mail to support@draytek.com.

Be a Registered Owner

Web registration is preferred. You can register your Vigor router via <https://myvigor.draytek.com>.

Firmware & Tools Updates

Due to the continuous evolution of DrayTek technology, all routers will be regularly upgraded. Please consult the DrayTek web site for more information on newest firmware, tools and documents.

<https://www.draytek.com>