

DrayTek

Vigor2960 Series

Dual-WAN Security Firewall



Quick Start Guide

V1.5

Vigor2960 Series Dual-WAN Security Firewall Quick Start Guide

Version: 1.5

Firmware Version: V1.3.0

(For future update, please visit [DrayTek web site](#))

Date: January 20, 2017

Intellectual Property Rights (IPR) Information

Copyrights

© All rights reserved. This publication contains information that is protected by copyright. No part may be reproduced, transmitted, transcribed, stored in a retrieval system, or translated into any language without written permission from the copyright holders.

Trademarks

The following trademarks are used in this document:

- Microsoft is a registered trademark of Microsoft Corp.
- Windows, Windows 95, 98, Me, NT, 2000, XP, Vista, 7, 8 and Explorer are trademarks of Microsoft Corp.
- Apple and Mac OS are registered trademarks of Apple Inc.
- Other products may be trademarks or registered trademarks of their respective manufacturers.

Safety Instructions and Approval

Safety

Instructions

- Read the installation guide thoroughly before you set up the router.
- The router is a complicated electronic unit that may be repaired only by authorized and qualified personnel. Do not try to open or repair the router yourself.
- Do not place the router in a damp or humid place, e.g. a bathroom.
- Do not stack the routers.
- The router should be used in a sheltered area, within a temperature range of +5 to +40 Celsius.
- Do not expose the router to direct sunlight or other heat sources. The housing and electronic components may be damaged by direct sunlight or heat sources.
- Do not deploy the cable for LAN connection outdoor to prevent electronic shock hazards.
- Keep the package out of reach of children.
- When you want to dispose of the router, please follow local regulations on conservation of the environment.

Warranty

We warrant to the original end user (purchaser) that the router will be free from any defects in workmanship or materials for a period of two (2) years from the date of purchase from the dealer. Please keep your purchase receipt in a safe place as it serves as proof of date of purchase. During the warranty period, and upon proof of purchase, should the product have indications of failure due to faulty workmanship and/or materials, we will, at our discretion, repair or replace the defective products or components, without charge for either parts or labor, to whatever extent we deem necessary to restore the product to proper operating condition. Any replacement will consist of a new or re-manufactured functionally equivalent product of equal value, and will be offered solely at our discretion. This warranty will not apply if the product is modified, misused, tampered with, damaged by an act of God, or subjected to abnormal working conditions. The warranty does not cover the bundled or licensed software of other vendors. Defects which do not significantly affect the usability of the product will not be covered by the warranty. We reserve the right to revise the manual and online documentation and to make changes from time to time in the contents hereof without obligation to notify any person of such revision or changes.

European Community Declarations

Manufacturer: DrayTek Corp.

Address: No. 26, Fu Shing Road, HuKou Township, HsinChu Industrial Park, Hsin-Chu
County, Taiwan 303

Product: Vigor2960 Series

DrayTek Corp. declares that Vigor2960 of routers are in compliance with the following essential requirements and other relevant provisions of EC, Directive 2004/108/EC.

The product conforms to the requirements of Electro-Magnetic Compatibility (EMC) Directive 2004/108/EC by complying with the requirements set forth in EN55022/Class A and EN55024/Class A.

The product conforms to the requirements of Low Voltage (LVD) Directive 2006/95/EC by complying with the requirements set forth in EN60950-1.

Regulatory Information

Federal Communication Commission Interference Statement

This equipment has been tested and found to comply with the limits for a Class A digital device, pursuant to Part 15 of the FCC Rules. These limits are designed to provide reasonable protection against harmful interference in a residential installation. This equipment generates, uses and can radiate radio frequency energy and, if not installed and used in accordance with the instructions, may cause harmful interference to radio communications. However, there is no guarantee that interference will not occur in a particular installation. If this equipment does cause harmful interference to radio or television reception, which can be determined by turning the equipment off and on, the user is encouraged to try to correct the interference by one of the following measures:

- Reorient or relocate the receiving antenna.
- Increase the separation between the equipment and receiver.
- Connect the equipment into an outlet on a circuit different from that to which the receiver is connected.
- Consult the dealer or an experienced radio/TV technician for help.

This device complies with Part 15 of the FCC Rules. Operation is subject to the following two conditions:

(1) This device may not cause harmful interference, and

(2) This device may accept any interference received, including interference that may cause undesired operation.



More update, please visit www.draytek.com.

Be a Registered Owner

Web registration is preferred. You can register your Vigor router via <http://www.draytek.com>.

Firmware & Tools Updates

Due to the continuous evolution of DrayTek technology, all routers will be regularly upgraded. Please consult the DrayTek web site for more information on newest firmware, tools and documents. <http://www.draytek.com>

Table of Contents

1. Introduction.....	1
2. Package Content	2
3. Panel Explanation.....	3
4. Hardware Installation	5
4.1 Connecting Device	5
4.2 Wall-Mounted Installation	6
5. Software Configuration	7
5.1 Accessing Web Page	7
5.2 Changing the Password	8
5.3 Quick Start Wizard for Network Connection.....	9
Step 1	9
Step 2	11
5.4 Check the Connection Status.....	16
6. Customer Service	16

1. Introduction

Vigor2960 series, a firewall broadband router with dual-WAN interface, can connect to xDSL/cable/VDSL2/Ethernet FTTx. The WAN and 4-port gigabit LAN switch facilitates unified communication applications in business CO/remote site to handle large data from subscribed fatter pipe. The state-of-art routing feature, VPN security, and Dual-WAN provide integrated benefits for professional users and small offices.



Vigor2960 series provides policy-based load-balance, fail-over and BOD (Bandwidth on Demand), also it integrates IP layer QoS, NAT session/bandwidth management to help users control works well with large bandwidth.

By adopting hardware-based VPN platform, hardware encryption of AES/DES/3DES and hardware key hash of SHA-1/MD5, the router increases the performance of VPN greatly, and offers several protocols (such as IPSec/PPTP/L2TP) with VPN tunnels.

The Object-based design used in SPI (Stateful Packet Inspection) firewall allows users to set firewall policy with ease. CSM (Content Security Management) provides users control and management in IM (Instant Messenger), P2P (Peer to Peer), URL Content Filter and Web Content Filter more efficiency than before. By the way, DoS/DDoS prevention and URL/Web content filter strengthen the security outside and control inside.

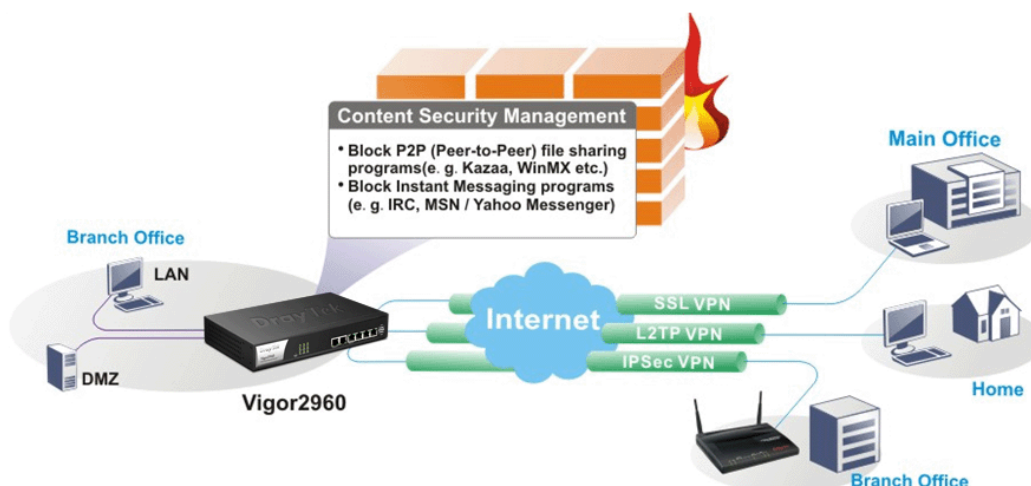

2. Package Content

Take a look at the package content. If there is anything missed or damaged, please contact DrayTek or dealer immediately.



Vigor router

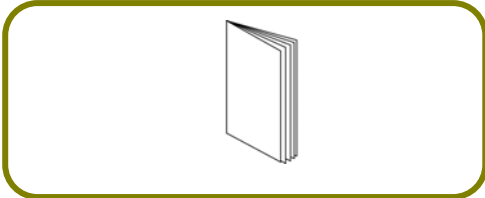

Quick Start Guide

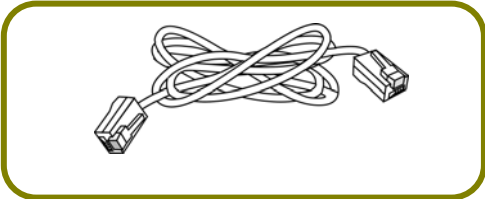

RJ-45 Cable (Ethernet)

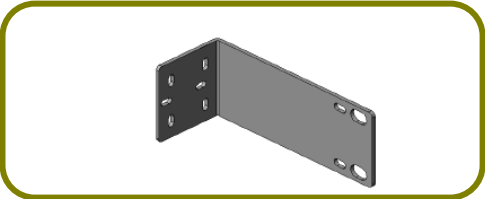

Rack mount kit (brackets)

The type of the power adapter depends on the country that the router will be installed. * The maximum power consumption is *20 Watt*.

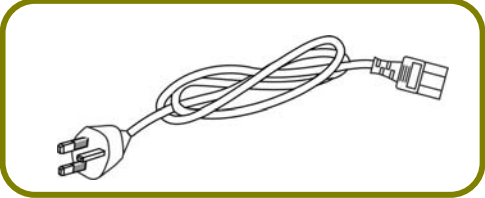

UK-type Power Cord

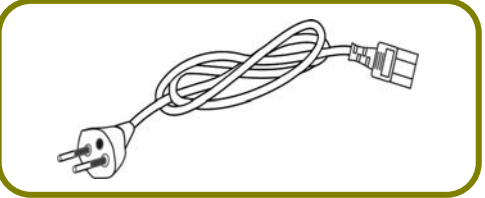

EU-type Power Cord

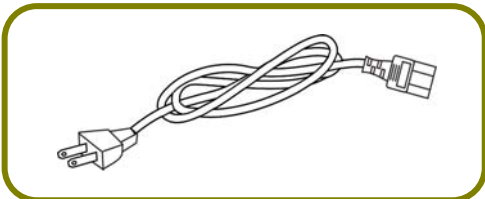

USA/Taiwan-type Power Cord

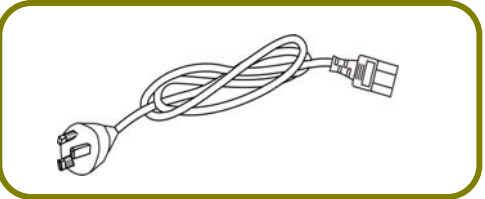

AU/NZ-type Power Cord

3. Panel Explanation

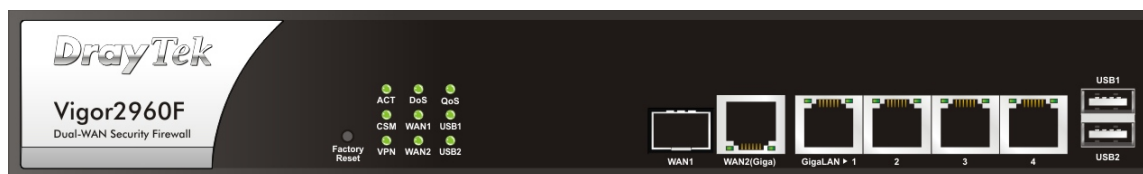
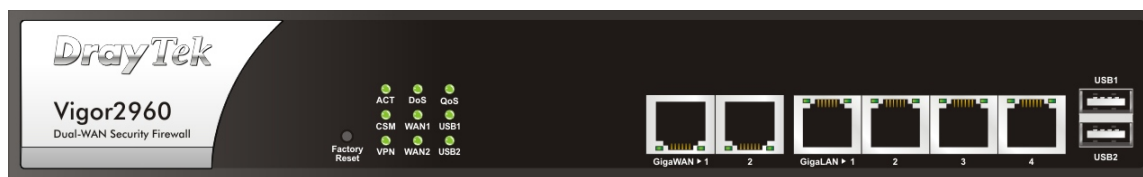



LED	Status	Explanation
ACT (Activity)	Blinking	The router is powered on and running normally.
	Off	The router is powered off.
CSM	On	The profile(s) of CSM (Content Security Management) for IM/P2P, URL/Web Content Filter application can be enabled from Firewall >>General Setup. (Such profile must be established under CSM menu).
VPN	On	The VPN tunnel is active.
	Off	VPN services are disabled.
	Blinking	Traffic is passing through VPN tunnel.
DoS	On	The DoS/DDoS function is active.
	Blinking	It will blink while detecting an attack.
WAN1/2	On	Internet connection is ready.
	Off	Internet connection is not ready.
	Blinking	The data is transmitting.
QoS	On	The QoS function is active.
	Off	The QoS function is disabled.
USB1/2	On	USB device is connected and ready for use.
	Blinking	The data is transmitting.
DoS	On	The DoS function is active.
	Blinking	It will blink while detecting an attack.

LED on Connector

GigaWAN1/2	Left LED	On	The port is connected.
		Off	The port is disconnected.
		Blinking	The data is transmitting.
	Right LED	On	The port is connected with 1000Mbps.
		Off	The port is connected with 10/100Mbps
		Blinking	The data is transmitting.
GigaLAN	Left LED	On	The port is connected.
		Off	The port is disconnected.

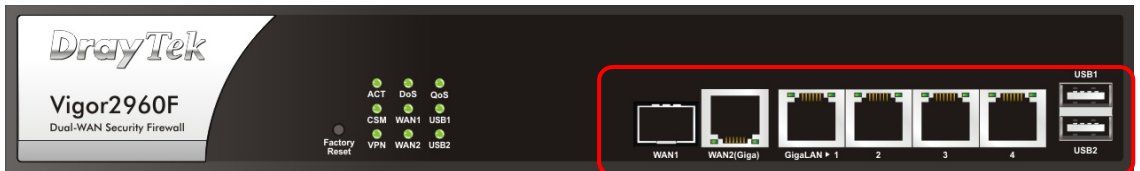
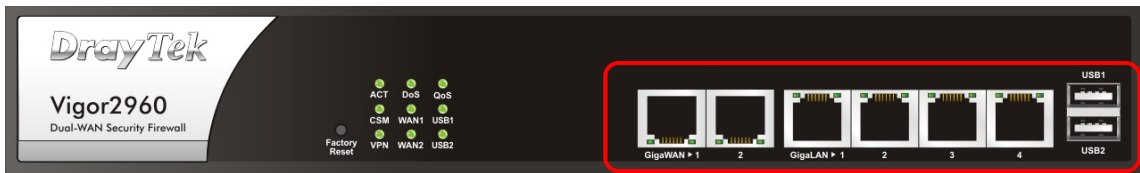
1~4		Blinking	The data is transmitting.
	Right LED	On	The port is connected with 1000Mbps.
		Off	The port is connected with 10/100Mbps
		Blinking	The data is transmitting.



Interface	Description
Factory Reset	Restore the default settings. Usage: Turn on the router (ACT LED is blinking). Press the hole and keep for more than 5 seconds. When you see the ACT LED begins to blink rapidly than usual, release the button. Then the router will restart with the factory default configuration.
GigaWAN 1/2 (Vigor2960)	Connector for local network devices or modem for accessing Internet.
WAN1 (Vigor2960F)	Fiber connector for accessing Internet.
WAN2(Giga) (Vigor2960F)	Connector for local network devices or modem for accessing Internet.
GigaLAN 1~4	Connectors for local network devices.
USB1/2	Connector for Mobile HDD, 3G Modem or printer.
	Connector for a power cord. ON/OFF - Power switch.

4. Hardware Installation

This section will guide you to install the router through hardware connection and configure the router's settings through web browser.

4.1 Connecting Device

Before starting to configure the router, you have to connect your devices correctly.

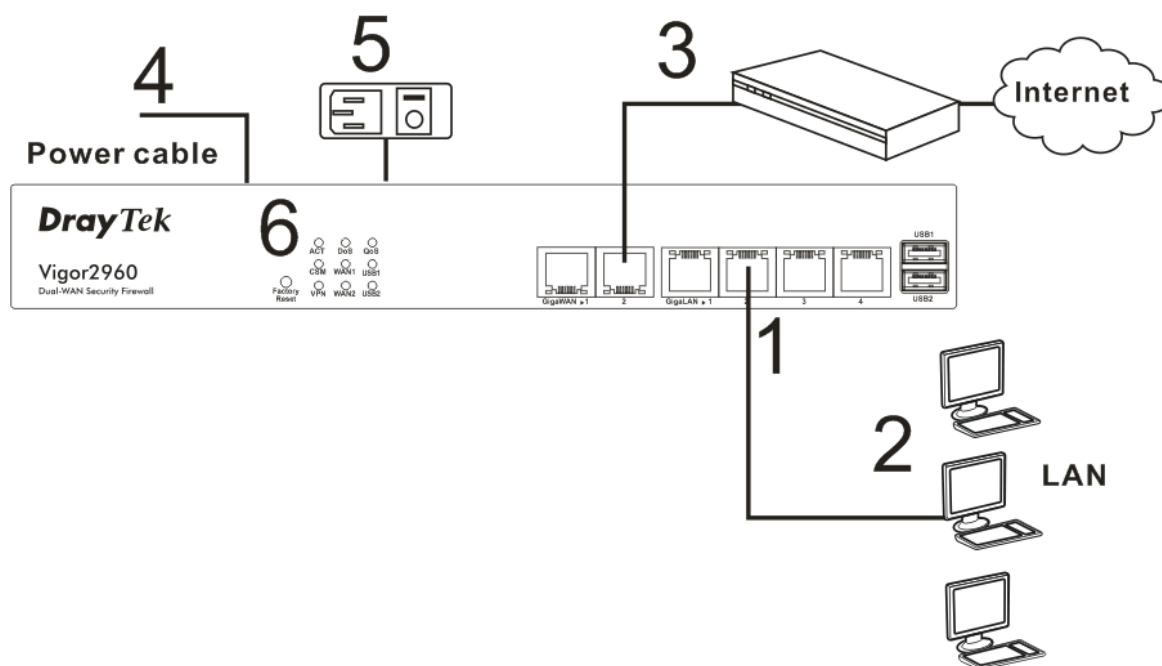

1. Connect one end of an Ethernet cable (RJ-45) to one of the LAN ports of Vigor2960.
2. Connect the other end of the cable (RJ-45) to the Ethernet port on your computer (that device also can connect to other computers to form a small area network). The LAN LED for that port on the front panel will light up.
3. Connect the cable Modem/DSL Modem/Media Converter to any WAN port of router with Ethernet cable (RJ-45).
4. Connect the power cord to Vigor2960's power port on the rear panel, and the other side into a wall outlet.
5. Power on the device by pressing down the power switch on the rear panel. The PWR LED should be ON.
6. The system starts to initiate. After completing the system test, the ACT LED will light up and start blinking.

(For the detailed information of LED status, please refer to section 1.1.)

4.2 Wall-Mounted Installation

The Vigor2960 Series can be mounted on the wall by using standard brackets shown below.

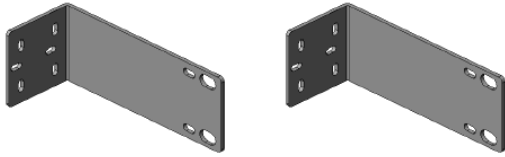

Choose a flat surface (on the wall) which is suitable for placing the router. Make the screw holes on the short side of the bracket aim at the screw holes on the router. Next, fasten both the bracket and the router with two screws; and fasten both the wall and the bracket with another two screws. Refer to the following figure.

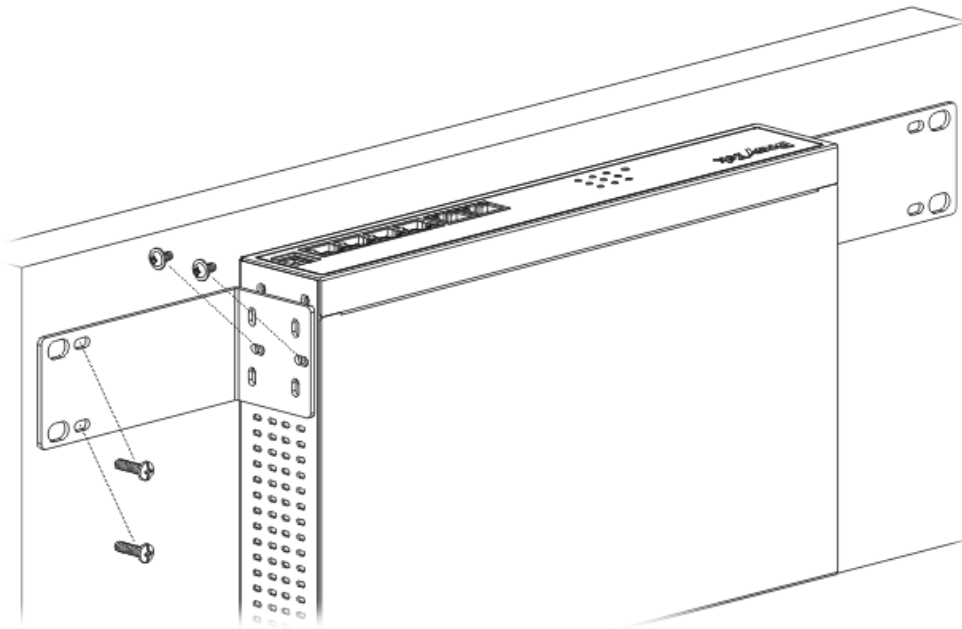

Then, continue to fasten the screws on the other side of the router and the wall with other screws.

When you finished about procedure, the router has been mounted on the wall firmly.

5. Software Configuration

To access Internet, please finish basic configuration after completing the hardware installation.

5.1 Accessing Web Page

1. Make sure your PC connects to the router correctly.



Note

You may either simply set up your computer to get IP dynamically from the router or set up the IP address of the computer to be the same subnet as the default IP address of Vigor router 192.168.1.1. For the detailed information, please refer to - Trouble Shooting of the user's guide.

2. Open a web browser on your PC and type http://192.168.1.1. The following window will be open to ask for username and password.

The screenshot shows the login interface for a DrayTek Vigor2960 Series router. At the top, there is a red banner with the 'DrayTek' logo on the left and 'Vigor2960 Series' on the right. Below this is a black bar with the word 'Login' in white. The main area is white and contains a login form. The form has three input fields: 'User : admin', 'Password : ●●●●●', and a language dropdown menu currently set to 'English'. To the right of the language dropdown is a 'Login' button.

3. Please type "admin/admin" on Username/Password and click **Login**.



Note

If you fail to access to the web configuration, please go to "Trouble Shooting" on User's Guide for detecting and solving your problem.

4. The web page can be logged out according to the chosen condition. The default setting is **5Min**, which means the web configuration system will logout after five minutes without any operation. Change the setting for your necessity.

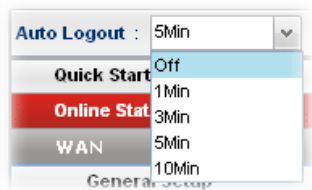

5. Now, the Main Screen will pop up.

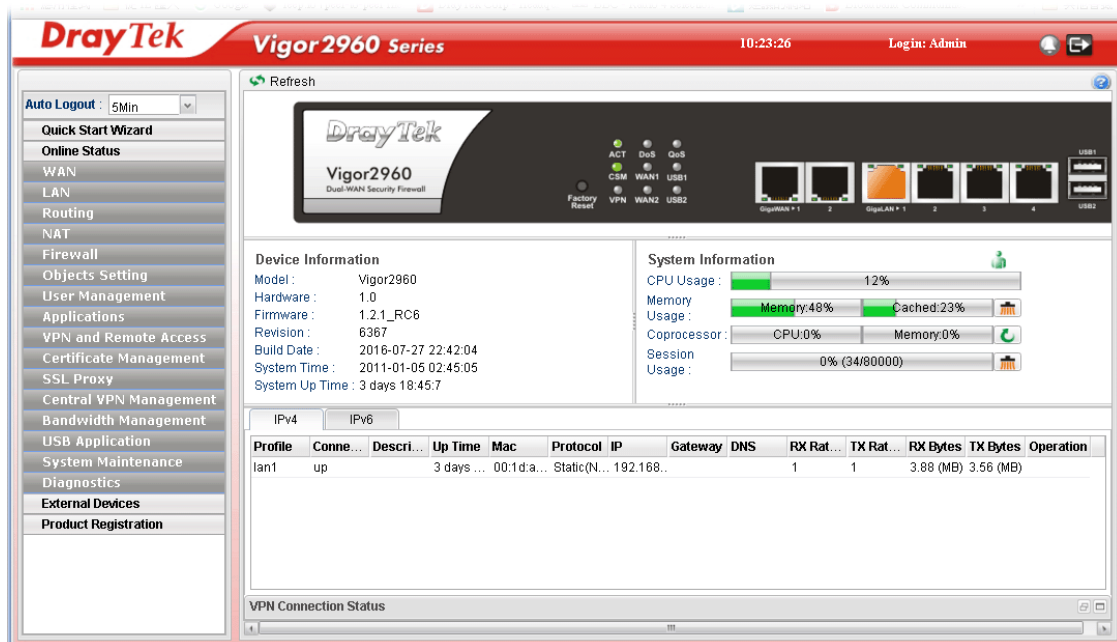

5.2 Changing the Password

The first job that you have to do is changing the user password. Follow the steps below to modify:

1. Go to System Maintenance page and choose Administrator Password.

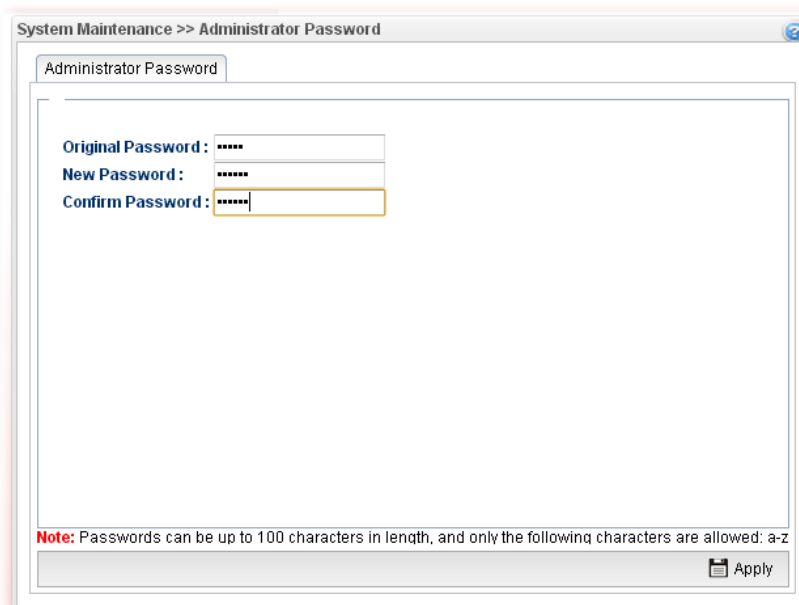

2. Enter the login password on the field of **Original Password**. Type a new one in the field of **New Password** and retype it on the field of **Confirm Password**. Then click **Apply** to continue.
3. Now, the password has been changed. Next time, use the new password to access the Web User Interface for this router.

5.3 Quick Start Wizard for Network Connection

Quick Setup is a wizard which is designed for configuring your router accessing Internet with simply steps. In the Quick Setup group, you can configure the router to access the Internet with different modes such as Static, DHCP, PPPoE, or PPTP modes.

Step 1

In the first page of Quick Start Wizard, please create a WAN profile.

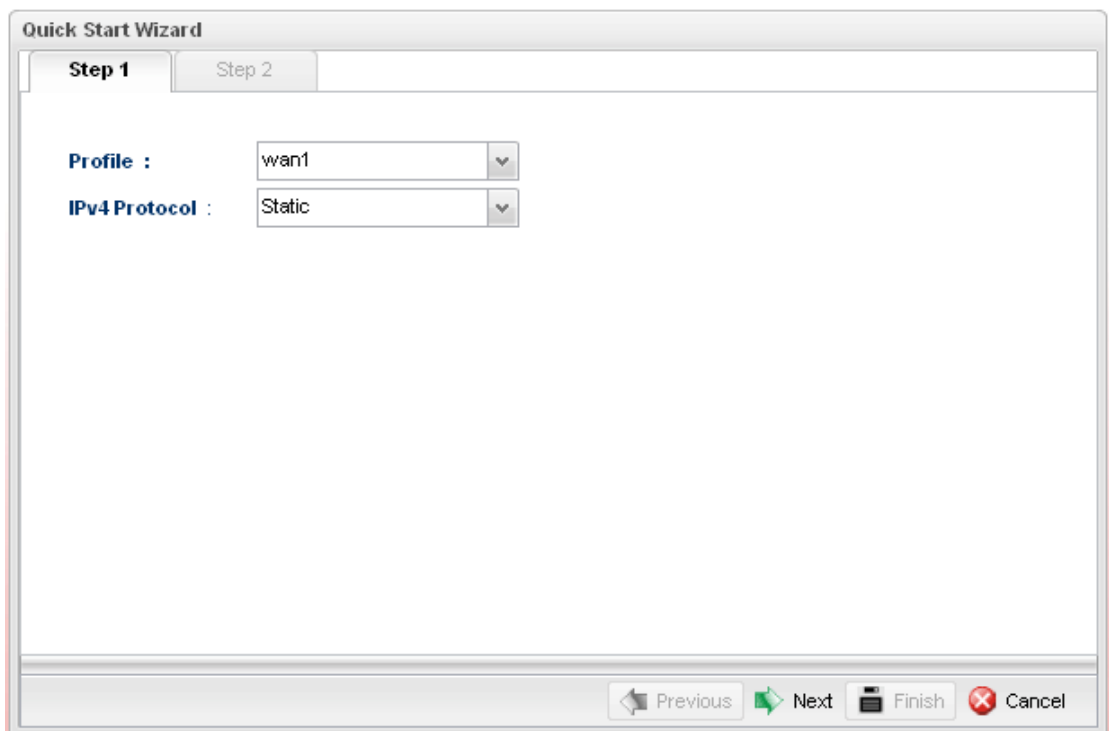

Available settings are explained as follows:

Item	Description
Profile	Use the drop down list to choose one WAN profile.
IPv4 Protocol Type	Use the drop down list to choose a connection mode for such WAN profile. <div style="display: flex; align-items: flex-start;"> <div style="margin-right: 10px;">IPv4 Protocol :</div> <div style="border: 1px solid gray; padding: 5px;"> <div style="display: flex; justify-content: space-between; align-items: center;"> Static ▼ </div> <div style="background-color: #e0f0ff; padding: 2px;">Static</div> <div style="padding: 2px;">DHCP</div> <div style="padding: 2px;">PPPoE</div> <div style="padding: 2px;">PPTP</div> </div> </div>

Item	Description
	<p>Static - If Static is selected, you can manually assign a static IP address to the WAN interface and complete the configuration by applying the settings and rebooting your router. Please type in values for IP address, Subnet Mask, Gateway IP Address and DNS Server IP Address specified by your ISP, and then click Next.</p> <p>DHCP - It allows a user to obtain an IP address automatically from a DHCP server on the Internet. If you choose DHCP mode, the DHCP server of your ISP will assign a dynamic IP address for Vigor2960 automatically. It is not necessary for you to assign any setting. (Host Name and Domain Name are required for some ISPs).</p> <p>PPTP - This mode lets user get the IP group information by a DSL modem with PPTP service from ISP. Your service provider will give you user name, password, and authentication mode for a PPTP setting. Click PPTP as the protocol. Type in all the information that your ISP provides for this protocol.</p> <p>If your ISP offers you PPTP (Point-to-Point Tunneling Protocol) mode, please select PPTP for this router. Next, enter the required information provided by your ISP on the web page.</p> <p>PPPoE - PPPoE stands for Point-to-Point Protocol over Ethernet. It relies on two widely accepted standards: PPP and Ethernet. It connects users through an Ethernet to the Internet with a common broadband medium, such as a single DSL line, wireless device or cable modem. All the users over the Ethernet can share a common connection.</p> <p>PPPoE is used for most of DSL modem users. All local users can share one PPPoE connection for accessing the Internet. Your service provider will provide you information about user name, password, and authentication mode.</p> <p>If your ISP provides you the PPPoE (Point-to-Point Protocol over Ethernet) connection, please select PPPoE for this router to get the following page. Enter the username and password provided by your ISP on the web page.</p>

When you finish the above settings, please click **Next** to go to next page.

Step 2



After clicking **Next**, you can see the following page which will vary according to the IPv4 protocol type selected in Step 1.

For **Static** type, the page will be displayed as follows:

The screenshot shows the 'Quick Start Wizard' window at 'Step 2'. The 'IP Address' field is set to 172.16.3.103, 'Subnet Mask' is 255.255.0.0, and 'Gateway IP Address' is 172.16.1.1. There is an 'Add' button and a 'Save' button. Below these is a table for 'DNS Server IP Address' which is currently empty, showing 'No items to show.'. At the bottom, there are 'Previous', 'Next', 'Finish', and 'Cancel' buttons.

Available settings are explained as follows:

Item	Description
IP Address	Type the IP address of the router for the WAN profile.
Subnet Mask	Type the network mask of the router for the WAN profile.
Gateway IP Address	Use the default setting (0.0.0.0). Such IP address is ready for matching with the function of Virtual System.
DNS Server IP Address	Type a public IP address as the primary DNS (Domain Name Server). To add a new IP address, simply Add . Four boxes will appear for you to type the IP address. When you finish the settings, click Save .

Item	Description
	 <p>Add - Click this button to have a field for adding a new IP address.</p> <p>Save - Click this button to save the configuration.</p> <p> - click the icon to remove the selected entry.</p>
Previous	Click it to return to previous setting page.
Finish	Click it to save the configuration and exit the dialog.
Cancel	Click it to discard the settings configured in this page.

For DHCP type, the page will be displayed as follows:

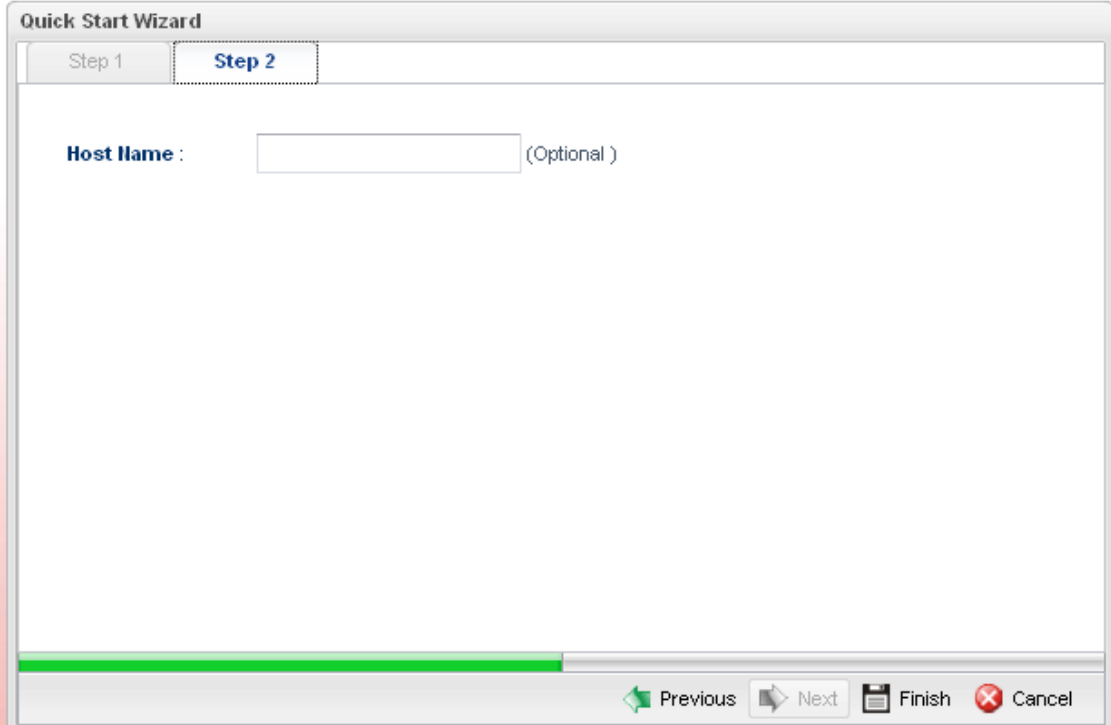

Type a name as the host name for identification (optional) for identification. Click **Finish**.

For PPPoE type, the page will be displayed as follows:

Quick Start Wizard

Step 1 Step 2

Username : 73768635@hinet.net

Password : [masked]

Previous Next Finish Cancel

Available settings are explained as follows:

Item	Description
Username	Type in the username provided by ISP in this field
Password	Type in the password provided by ISP in this field.
Previous	Click it to return to previous setting page.
Finish	Click it to save the configuration and exit the dialog.
Cancel	Click it to discard the settings configured in this page.

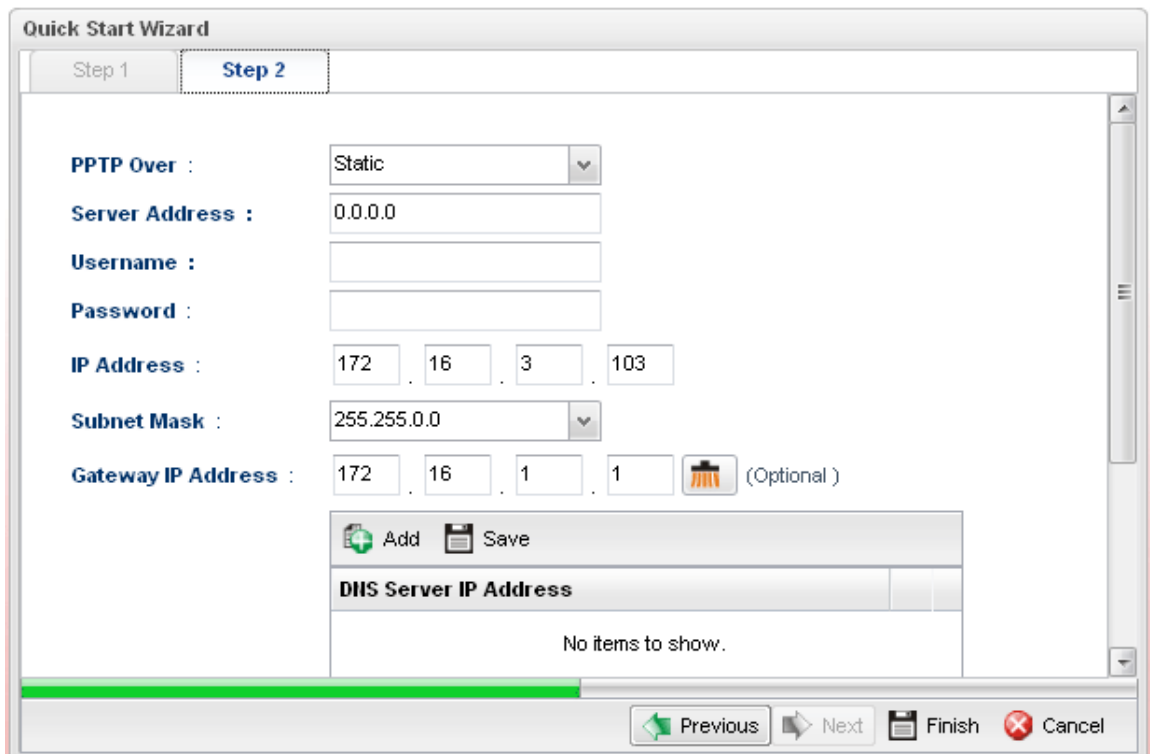

After finishing the above configuration, click **Finish**.

For PPTP type, the page will be displayed as follows:

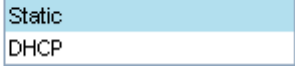

Available settings are explained as follows:

Item	Description
PPTP Over	<p>Usually ISP dynamically assigns IP address to you each time you connect to it and request. In some case, your ISP provides service to always assign you the same IP address whenever you request. In this case, you can fill in this IP address in the Fixed IP field. Please contact your ISP before you want to use this function.</p> <p>PPTP Over : </p> <p>Server Address : </p> <p>Static - Specify the IP address. DHCP - Obtain the IP address automatically.</p>
Server Address	Type a remote IP address of PPTP server.
Username	Type in the username provided by ISP in this field.
Password	Type in the password provided by ISP in this field.
Gateway IP Address	Use the default setting (0.0.0.0).
DNS Server IP Address	Type a public IP address as the primary DNS (Domain Name Server). To add a new IP address, simply Add. Four boxes will appear for you to type the IP address. When you finish the settings, click Save.

Item	Description
	 <p>Add - Click this button to have a field for adding a new IP address.</p> <p>Save - Click this button to save the configuration.</p> <p> - click the icon to remove the selected entry.</p>
Previous	Click it to return to previous setting page.
Finish	Click it to save the configuration and exit the dialog.
Cancel	Click it to discard the settings configured in this page.

After finishing the above configuration, click **Finish**.

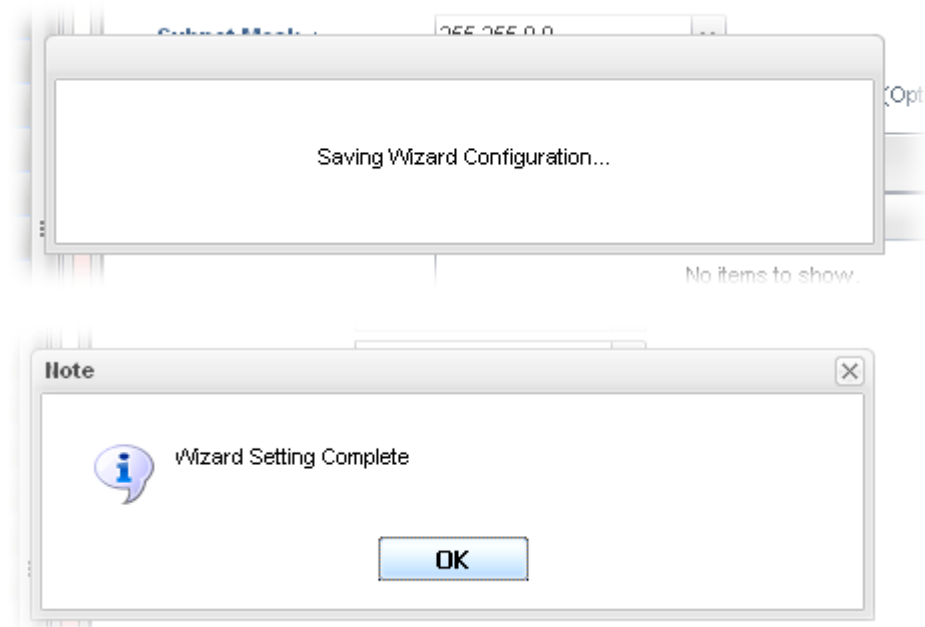

Later, you can surf the Internet at any time.

5.4 Check the Connection Status

After finishing the WAN connection, please check the connection status to ensure the network connection has been made successfully.

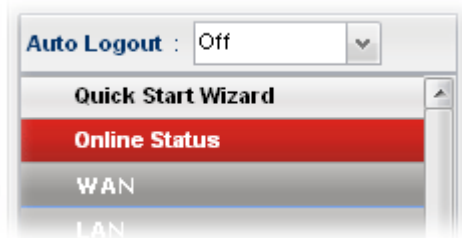

Please open **Online Status** to display the information for all the WAN interfaces at the same time, including Device Information, System Information and IPv4/IPv6 configurations.

Device Information

Model : Vigor2960
Hardware : 1.0
Firmware : 1.2.1_RC6
Revision : 6367
Build Date : 2016-07-27 22:42:04
System Time : 2011-01-05 02:45:05
System Up Time : 3 days 18:45:7

System Information

CPU Usage : 12%
Memory Usage : Memory:48% Cached:23%
Coprocesor : CPU:0% Memory:0%
Session Usage : 0% (34/80000)

IPv4 IPv6

Profile	Conne...	Descri...	Up Time	Mac	Protocol	IP	Gateway	DNS	RX Rat...	TX Rat...	RX Bytes	TX Bytes	Operation
wan1	up		3 days ...	00:1d:a...	Static(N...	192.168..			1	1	3.88 (MB)	3.56 (MB)	

VPN Connection Status

From the above figure, wan1 connection for Internet has been built successfully for the word - **up** has been displayed on the field of **Connection**.

6. Customer Service

If the router cannot work correctly after trying many efforts, please contact your dealer for further help right away. For any questions, please feel free to send e-mail to support@draytek.com.